

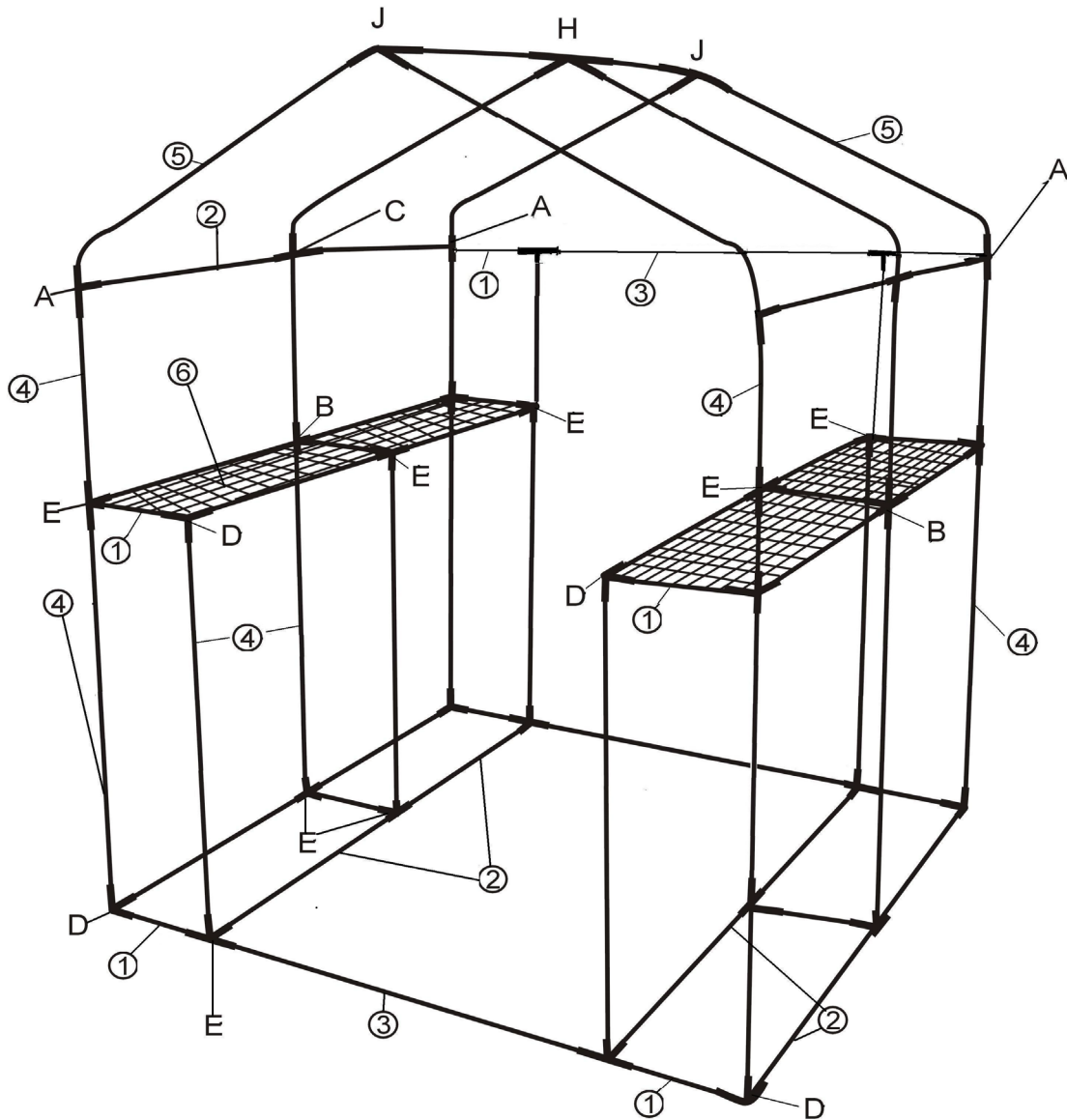













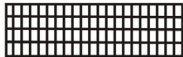

FIN Asennusohjeet SE Instruktioner

Kasvihuone



①		14	A		4
②		22	B		2
③		3	C		2
④		20	D		6
⑤		6	E		18
⑥		4	H		1
⑦		1	J		2